

Barierka #18

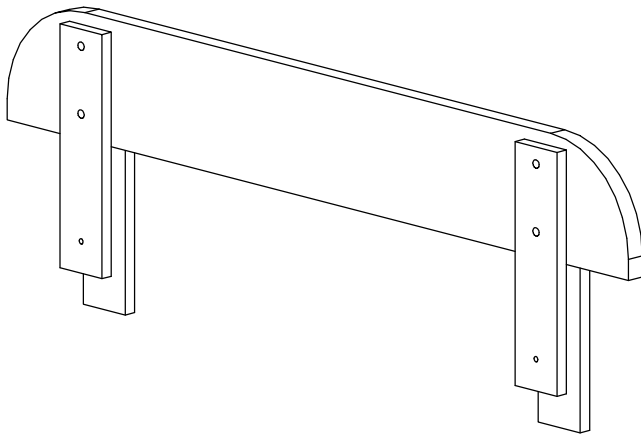

Narzędzia
Tools required
Outillage necessaire
Werzeuge



Colli 1/1:

Nr 1 -1 szt.

Nr 2 -2 szt.

Nr 3 -2 szt.

Okucia/Fittings/Beschlage

Instrukcja montażu/Assembly
instruction/Montageanleitung

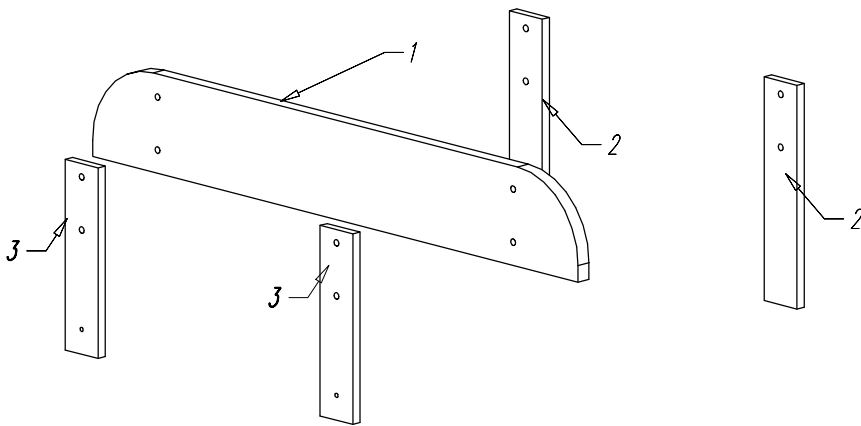
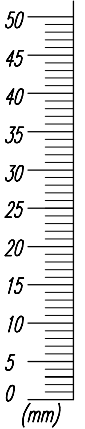

M6x35
x4



ER Ø8x15

x4



Ø3.5x25

x2

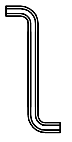

SW4

x2

